

FBS BM1 ALUMIINIRULOT /Tilauslomake (Order sheet)

Tilaus (Order)

Tarjouspyyntö (Inquiry)

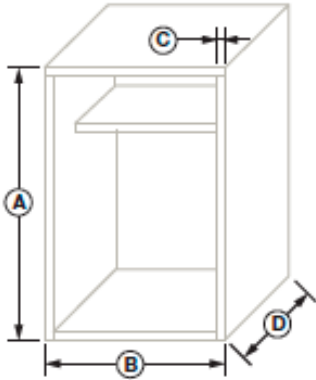

Kaapin mitat (mm) (Cabinet dimensions mm)

A	B	C	D	Kpl (Quantity)

Vaihtoehdot (Options)

Merkitse haluamasi vaihtoehto

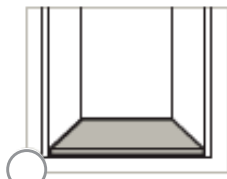

Pohjallinen kaappi
(Box with basement)

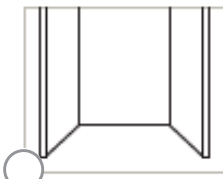

Kaappi ilman pohjaa
(Box without basement)

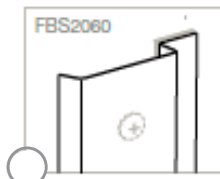

FBS2060
(Screw cover profile)

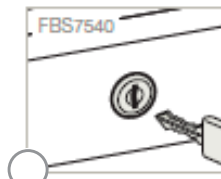

Rulo-ovi lukolla
(Lock)

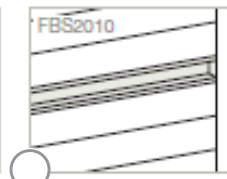

Rulo-ovi vedinprofiililla
(Intermediate handle)



standard

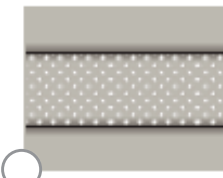

wind mix

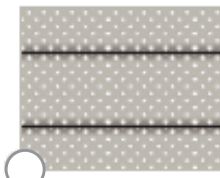

wind

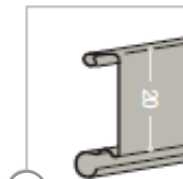

FBS2020

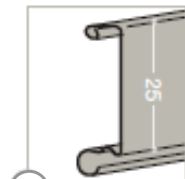

FBS2125

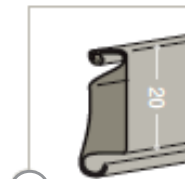

FBS2000
(Reinforced)

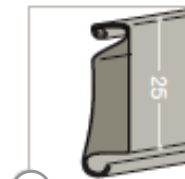

FBS2025
(Reinforced)

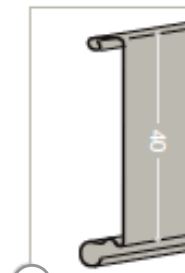

FBS2140



FBS2140
(Reinforced)

Pinta (Finishing)

ANODISOITU /ANODIZED

- A - harjattu alumiini
(brushed)
- A2 - harjattu rst look
(inox brushed)
- B - rst
(mill finish)
- B2 - rst look
(mill inox)

- BR2 - matta pronssi
(matt bronze)
- SN - hopea
(sat nat)
- RA - kupari
(copper)
- B3 - kulta
(mill gold)

MAALATTU ALUMIINI /PREPAINTED

- U5 - matta alumiini
(alumatt)
- U6 - rst look
(inox)
- M3 - valkoinen
(white)

- M4 - matta valkoinen
(matt white)
- L2 - matta musta
(matt black)
- U8 - harjattu pronssi
(brushed bronze)
- U9 - antrasiitti
(anthracite)

PUUKUVIO

- MO01 - mahonki
(mahogany)
- FR01 - saarni
(ash)
- NC01 - pähkinä
(walnut)

(Some type of slat are not available in all the finishing)